

# Elsa

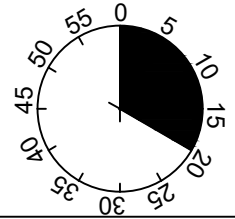
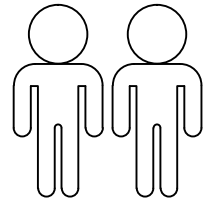
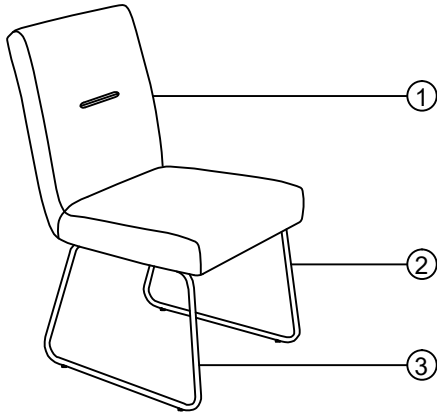

1

2

3

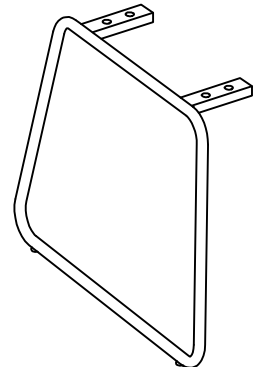
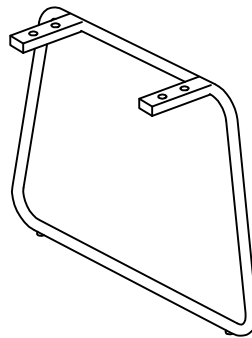
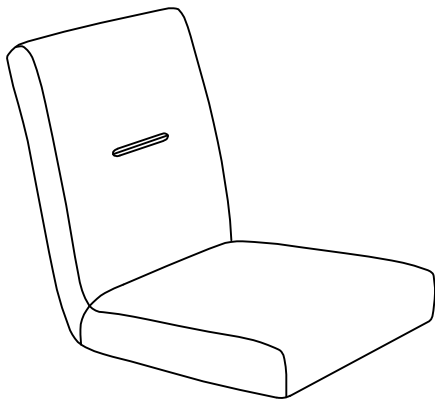

1	1X
2	1X
3	1X

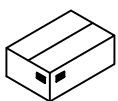

1/1

A

M8x35

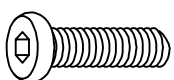

8x

B

Ø18xØ8x1.5



8x

C

5MM

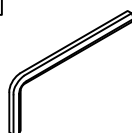



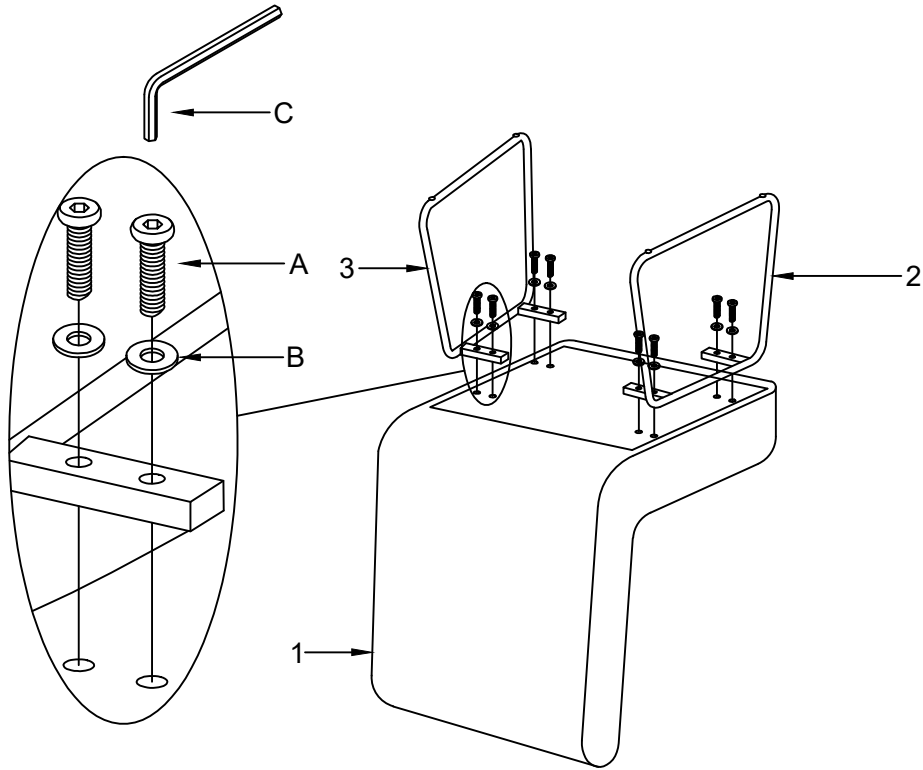

1x

I.



1

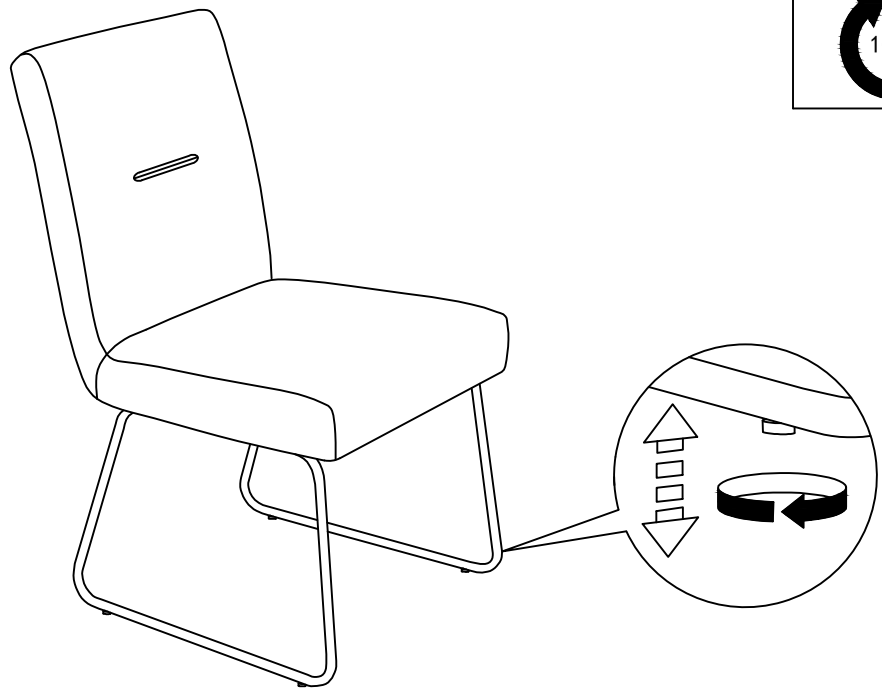

A	M8x35
	8x
B	Ø18xØ8x1.5
	8x
C	5MM
	1x
	75%

2



C	5MM
	1x
	100%



LE TRI  
+ FACILE



Séparez les éléments avant de trier